

LAV/SINK OUTLET BOX

▶▶ 696 SERIES

OxBox™

SPECIFICATION

Sioux Chief 696 series OxBox™ outlet box shall be used where necessary in plumbing systems. Unit shall allow for mounting with supply lines from top or bottom, on-stud or between-studs. Unit shall include plated, 1/4-turn valves with 3/8" compression outlet. Valve outlets shall be provided with tamper-resistant test caps. Metal support bracket can be installed into tracks of box. Designed in accordance with IAPMO PS 54-2021a.

MATERIALS

Valve body: Forged brass¹
Valve shank: Brass¹ or CPVC with 304SS grip ring, brass nut, silicone seal
Box/Frame: ABS
Arrester body: 304SS barrel with brass¹ body
Arrester piston: Polypropylene with EPDM o-rings
Bracket: Galvanized steel

CERTIFICATIONS/APPROVALS

NSF-372 compliant¹, IAPMO listed box and valves, Arresters meet ASSE 1010, Valves meet ASME A112.18.1

VALVE/ARRESTER WORKING LIMITS

Max Working Temperature: 200° F
Max Testing/Working Pressure: 150 PSIG

DIMENSIONS

A: Frame width	5-7/8"
B: Frame height	7-1/4"
C: Box width	4"
D: Box height	5-1/2"
E: Box depth	3-1/2"
F: Supply inlet	1/2" Nom., 2" O.C.
G: Supply outlet	3/8" Compression
Bracket length	18"

ITEM # SUBMITTED	_____
JOB NAME	_____
LOCATION	_____
ENGINEER	_____
CONTRACTOR	_____
PO#	_____ TAG _____

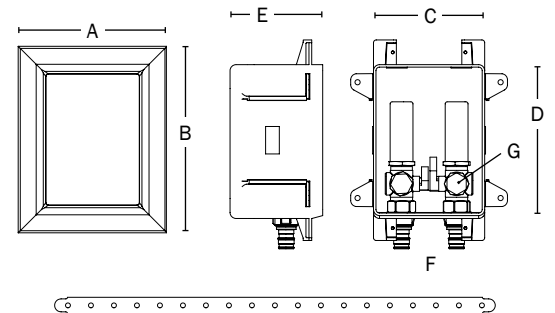

Create Item Number

696-ABC

e.g. **696-G2011XF**: Lavatory outlet box with frame; valve with arrester, F1807 connection

ARRESTERS **A**

G2001 = No arresters
G2011 = With arresters

SUPPLY CONNECTION **B**

C = CPVC (male)
M = MIP/FSWT
P = MSWT/Press/Push
V = F3347 PEX
W = F1960 PEX
X = F1807 PEX

FRAME OPTION **C**

F = Standard Pack: Outlet box, frame, bracket, and debris cover
R = Rough-in Pack: Outlet box, bracket, and debris cover

Accessories - Available Separately:
 696-1F: Single-box frame
 696-EX: Frame extension

¹ C69300 material is DZR and SCC resistant, compliant with NSF-61 & 372, and compliant with California No Lead Plumbing Law

